



4.500" x 5.750" Spiral

Dimensional Data	Value	Unit	Value	Unit
Casing Size	4.500	inches	114.3	mm
Outer Diameter (nominal)	5.750	inches	146.1	mm
Inner Diameter (nominal)	4.600	inches	116.8	mm
Length	8.00	inches	203	mm
Weight	2.57	lbs	1.17	kg
Blades	4			
Stop Collar	SCB044			

Technical Data	Value	Unit	Value	Unit
Flow Bypass Area (calculated to OD)	4.3	sq inches	2,770	sq mm
Service Temperature	-40 to 245	°C	-40 to 473	°F

Stop Collar - SCB044 - 4.500"

Dimensional Data	Value	Unit	Value	Unit
Casing Size	4.500	inches	114.3	mm
Outer Diameter (nominal)	5.196	inches	132.0	mm
Inner Diameter (nominal)	4.685	inches	119.0	mm
Length	1.50	inches	38	mm
Weight	1.54	lbs	0.70	kg
Grub Screw Holes	5			
Grub Screw Dimensions	1/2" x 3/8" lg			
Grub Screw Head Style	1/4" Hexagonal			

Technical Data	Value	Unit	Value	Unit
Collar Material	Mild Steel			
Grub Screw Material	Steel			
Grub Screw Recommended Torque	30	ft lbs	41	Nm

EzeeGLIDERS® come complete with integral metal anti-swage rings inset into each end
 EzeeGLIDERS® are available in BOS21 engineered polymer
 Stop Collar stainless steel grub screws available upon request
 Tested in accordance with API-10 TR5
 Custom sizes available upon request
 Dimensions are subject to change

Version: 2017-08-31

For more information

Visit www.innovex-inc.com or contact your local sales office.
 Domestic and international patents and trademarks granted and/or applied for where applicable.

THIS DOCUMENT IS PROVIDED IN STRICT CONFIDENCE AND MAY NOT BE DISCLOSED TO ANY THIRD PARTY OR USED FOR ANY OTHER PURPOSE WITHOUT THE EXPRESS WRITTEN PERMISSION OF INNOVEX.

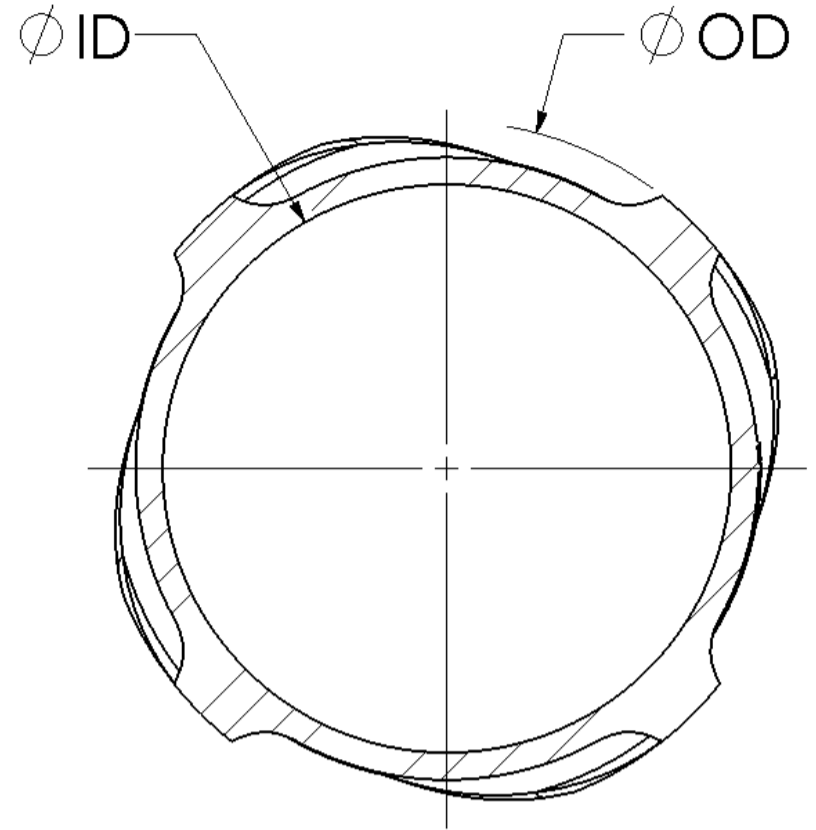
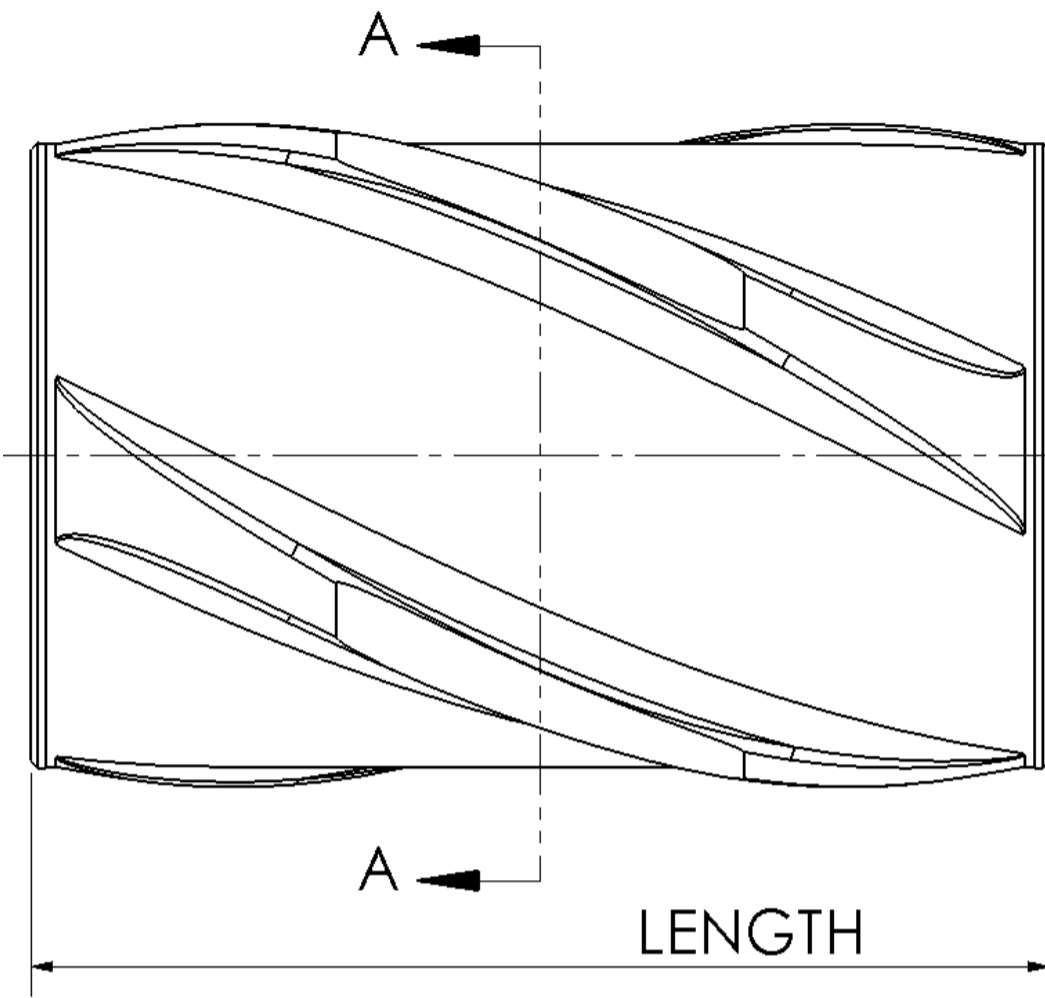

SECTION A-A

For more information

Visit www.innovex-inc.com or contact your local sales office.
Domestic and international patents and trademarks granted and/or applied for where applicable.

THIS DOCUMENT IS PROVIDED IN STRICT CONFIDENCE AND MAY NOT BE DISCLOSED TO ANY THIRD PARTY OR USED FOR ANY OTHER PURPOSE WITHOUT THE EXPRESS WRITTEN PERMISSION OF INNOVEX.